

Western & Marine Blocks



Ordering Instructions

IMPORTANT

Helpful Information and Recommended Procedure for the

CORRECT ORDERING OF WESTERN BLOCKS

In selecting blocks, the governing consideration should be the load to be handled, rather than diameter or strength of the rope they will support. In multiple sheave blocks the load is distributed among several parts of the rope, whereas the hooks or shackles on the blocks have to support the entire

load. It is not practical to make double blocks twice as strong and triple blocks three times as strong as single blocks, since they would be too heavy and needlessly expensive for general use.

WHEN ORDERING, ALWAYS SPECIFY:

Letter of Fitting, Block Series, Letter of Bearing, and Size.

EXAMPLE:

For ordering a 4" Single Wood Block with Loose Side Latch Hook, Common Iron Bearing, simply specify as follows:

HS-21-B 4"

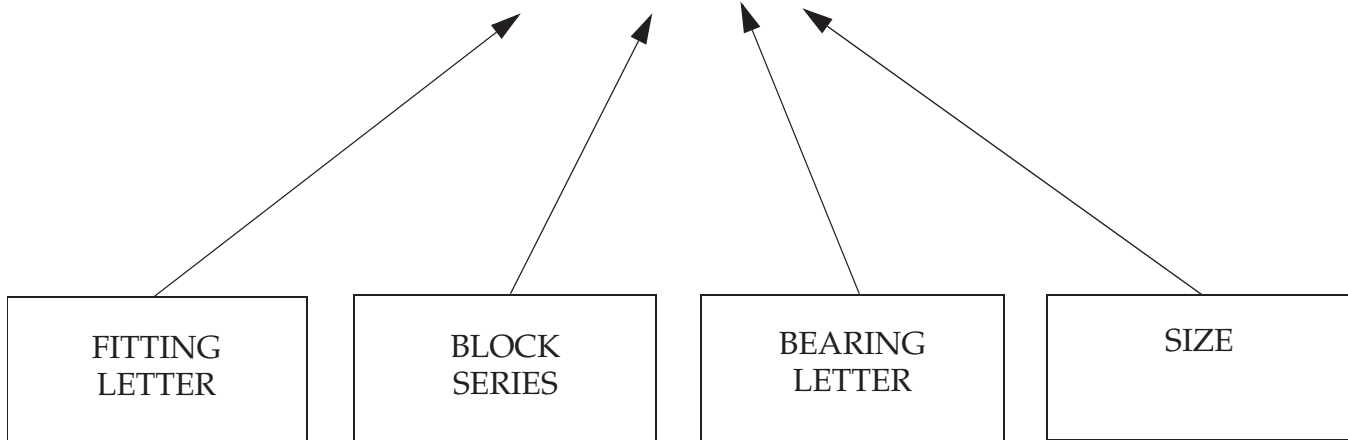

If blocks are not shown with type of fitting you require, simply choose letter corresponding to your fitting need and insert where "HS" appears in the above example.

Unless otherwise specified all material will be furnished in galvanized finish.

All Certified single blocks are proof tested to twice the Resultant Safe Working Load and marked with a working load equal to one half the resultant load. Double blocks are tested to twice the Resultant Safe Working Load and marked with a working load equal to the resultant load.

All blocks except snatch blocks are furnished with becket. Blocks without becket on special order only.

When blocks are used for heavy loads and fast hoisting, we strongly recommend roller or bronze bearings in the sheaves. For wire rope blocks, cast steel sheaves are recommended.

SPECIAL CUSTOM-MADE BLOCKS. . .

We manufacture a large number of Special Blocks to meet particular requirements. Specify type block, diameter of sheave, diameter of manila or wire rope to be used, and weight of load.

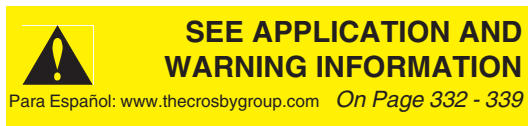

Western Blocks

THE NEW WESTERN BLOCK LINE

If today's technology was available over a century ago . . .
 . . . This is the way Western Blocks would have been produced.

- Bolt style center pin with lock washer and staked nut
- No straps
- Laser burned side plates
- Every block permanently stamped with the following:
 - Working Load Limit
 - Block Size
 - Rope Size

<p>385 Wood Shell Manila Rope Snatch Blocks</p>  <ul style="list-style-type: none"> • New stock numbers • New higher working load limits • Painted or galvanized steel with replaceable wood bumpers • Laser cut side plate opens for insertion of rope. <ul style="list-style-type: none"> - Incorporates exclusive bolt retaining spring to assure no lost bolts, plus utilizes secondary retaining pin. • Bronze bushed sheaves with larger bearing diameter for extended block life. • Lubricated center pin • 10" and 12" sizes utilize steel sheaves 	<p>301 - 302 - 303 Steel Shell Blocks for Manila Rope</p>  <ul style="list-style-type: none"> • Same stock numbers • Same working load limits • Same fittings available • Laser cut side plates • Galvanized steel • Grade 5 bolts secured with lock washers and staked nuts • Bronze bushed sheaves with larger bearing diameter for extended block life • New style hanger for fitting attachment 	<p>261 - 262 - 263 Standard Steel Shell Blocks for Manila Rope</p>  <ul style="list-style-type: none"> • Same stock numbers • Same working load limits • Same fittings available • Laser cut side plates • Painted steel • Grade 5 bolts secured with lock washers & staked nuts • Bronze bushed sheaves with larger bearing diameter for extended block life.
<p>390 Steel Shell Manila Rope Snatch Blocks</p>  <ul style="list-style-type: none"> • New stock numbers • New higher working load limits • Painted or galvanized steel • Laser cut side plate opens for insertion of rope. <ul style="list-style-type: none"> - Incorporates exclusive bolt retaining spring to assure no lost bolts, plus utilizes secondary retaining pin. • Bronze bushed sheaves with larger bearing diameter for extended block life. • Lubricated center pin • 10" and 12" sizes utilize steel sheaves 	<p>411 - 412 - 413 Steel Shell Blocks for Synthetic Rope</p>  <ul style="list-style-type: none"> • Same stock numbers • Same working load limits • Same fittings available • Laser cut side plates • Painted steel • Grade 5 bolts secured with lock washers & staked nuts • Bronze bushed sheaves with larger bearing diameter for extended block life. 	<p>261 - 262 5" Steel Shell Blocks for Wire Rope</p>  <ul style="list-style-type: none"> • Same stock numbers • Same working load limits • Same fittings available • Laser cut side plates • Painted steel • Grade 5 bolts secured with lock washers & staked nuts • Bronze bushed sheaves with larger bearing diameter for extended block life.
<p>130 - 135 Painter's Supply Blocks for Manila Rope</p>  <ul style="list-style-type: none"> • Same stock numbers • Same working load limits • Same fittings available • Laser cut side plates • Galvanized steel • Grade 5 bolts secured with lock washers & staked nuts • Replaceable wood bumpers • Bronze bushed sheaves with larger bearing diameter for extended block life. 	<p>21 - 22 - 23 Wood Shell Blocks for Manila Rope</p>  <ul style="list-style-type: none"> • Same stock numbers • Same working load limits • Same fittings available • Laser cut side plates • Galvanized steel • Grade 5 bolts secured with lock washers & staked nuts • Replaceable wood bumpers • Bronze bushed sheaves with larger bearing diameter for extended block life. 	<p>641 - 642 Diamond Pattern & 661 - 662 Oval Pattern Blocks</p>  <ul style="list-style-type: none"> • Same stock numbers • Same working load limits • Same fittings available • Laser cut side plates • Grade 5 bolts secured with lock washers & staker nuts • All sizes feature bronze bushed steel sheaves with larger bearing diameter for extended block life • Lubricated center pin available upon request • New style hanger for fitting attachment <ul style="list-style-type: none"> - Available with hanger only (on fitting) upon request

Western Manila Rope Blocks



SEE APPLICATION AND WARNING INFORMATION

Para Español: www.thecrosbygroup.com

On Pages 332-339



HS-21-B

Regular Wood Blocks for Manila Rope

- Laser cut side plates
- Grade 5 bolts secured with lock washers and staked nuts.
- Bronze bushed sheaves with larger bearing diameter for extended block life.
- Becketts furnished on all blocks. For reeving information, see page 336.

Block Size (in.)	Fitting	Single Sheave 21 B Stock No.	Double Sheave 22 B Stock No.	Triple Sheave 23 B Stock No.
4	HS	603831	604634	605438
5	HS	603859	604652	605456
6	HS	603877	604670	605474
8	HS	603911	604714	605517
4	N	606437	606838	607230
5	N	606455	606856	607258
6	N	606473	606874	607276
8	N	606516	606918	607310
4	S	610039	611635	613232
5	S	610057	611653	613250
6	S	610075	611671	613278
8	S	610119	611715	613312

Block Size (in.)	Sheave Dimensions (mm)			Manila Rope Size (mm)	Working Load Limit (t)*			Weight Each (kg.)		
	Outside Diam.	Rim Thickness	Center Pin Diam.		21 Single	22 Double	23 Triple	21 Single	22 Double	23 Triple
4	57.0	16.0	9.65	13	.45	.64	.82	.79	1.36	1.81
5	76.0	19.1	9.65	16	.54	.82	1.09	1.47	2.54	2.95
6	89.0	25.4	12.7	19	.82	1.13	1.45	2.27	3.86	5.22
8	121	28.7	16.0	22-26	1.27	1.72	2.18	4.08	6.35	9.75

* Ultimate Load is 4 times the Working Load Limit.



P-303-B

Steel Shell Blocks for Manila Rope

- Laser cut side plates
- Grade 5 bolts secured with lock washers and staked nuts.
- Bronze bushed sheaves with larger bearing diameter for extended block life.
- New style hanger for fitting attachment.

Block Size (in.)	Fitting	Single Sheave	Double Sheave	Triple Sheave
		301 B* Stock No.	302 B* Stock No.	303 B* Stock No.
4	HS	680971	681373	681774
6	HS	680999	681391	681792
8	HS	681015	681417	681818
4	N	682639	683031	683433
6	N	682675	683077	683479
8	N	682719	683111	683512
4	P	691031	692637	694234
6	P	691077	692673	694270
8	P	691111	692717	694314

* Bearing Code: B - Self Lubricating Bronze Bushed

Block Size (in.)	Sheave Size (mm)		Manila Rope Size (mm)	Working Load Limit (t)*			Weight Each (kg.)		
	Outside Diam.	Rim Thickness		Single	Double	Triple	Single	Double	Triple
4	57.2	16.0	13	.50	.73	1.00	1.02	1.70	2.27
6	89.0	25.4	19	.91	1.50	1.81	2.49	4.20	5.67
8	121	28.7	26	1.50	2.31	3.18	4.54	7.48	9.98

* Ultimate Load is 3.5 times the Working Load Limit.

Western Standard Steel Blocks

SEE APPLICATION AND WARNING INFORMATION
 Para Español: www.thecrosbygroup.com On Pages 332-339



HS-262 DOUBLE

Loose Side Hooks with Latch For Manila Rope

- Laser cut side plates
- Grade 5 bolts secured with lock washers and staked nuts.
- Bronze bushed sheaves with larger bearing diameter for extended block life.

Block Size (in.)	Fitting	Manila Rope Size (mm)	Sheave Size		261 B Stock No.	262 B Stock No.	263 B Stock No.	Working Load Limit (t)*			Weight Each (kg.)		
			Outside Diam. (mm)	Rim Thickness (mm)				261 Single	262 Double	263 Triple	261 Single	262 Double	263 Triple
4	HS	13	57.0	16.0	666826	666229	667228	.41	.64	.82	.63	1.46	1.47
5	HS	16	76.0	19.1	666844	666247	-	.54	.82	-	1.02	1.76	-
6	HS	19	89.0	25.4	666862	666265	-	.82	1.13	-	1.70	2.72	-
8	HS	22-26	121	28.7	666906	666309	667308	1.27	1.72	2.18	3.23	4.88	6.69

* Ultimate Load is 3 times the Working Load Limit.



N-411-B

Blocks for Synthetic Fiber Rope with loose swivel hooks

- These blocks are built to carry the increased loads of synthetic fiber ropes.
- All hooks are heat-treated alloy steel.
- You can now use a smaller size rope, and in turn, a smaller block, providing capacities which were previously not possible.

Block Size (in.)	Fitting	Stock No.		
		411 B* Stock No.	412 B* Stock No.	413 B* Stock No.
4	S	755105	755301	755506
6	S	755123	755329	755524
4	N	757103	757309	757504
6	N	757121	757327	757522

* Bearing Code: B-Self Lubricating Bronze Bushed

Block Size (in.)	Fitting	Sheave Size (mm)			Synthetic Rope Size (mm)	Working Load Limit (t)*			Weight Each (kg.)		
		Outside Diameter	Rim Thickness	Center Pin Dia.		Single	Double	Triple	Single	Double	Triple
4	S	57.2	15.8	9.65	13	.90	1.36	1.36	1.36	1.81	2.72
6	S	89.0	25.4	12.7	19	1.36	3.18	3.63	2.83	4.54	6.35
4	N	57.2	15.8	9.65	13	.91	1.36	1.36	1.36	1.81	2.72
6	N	89.0	25.4	12.7	19	1.36	1.81	2.72	2.83	4.54	6.35

* Ultimate Load is 4 times the Working Load Limit.



HW-261B

HW-261 HW-262 5" Steel Blocks

- For 10 mm diameter wire cable.
- Sheave Size: 76 x 19 x 10mm.

Block Size (in.)	Fitting	Block Stock No.	Catalog No.	Bearing Type	Wire Rope Size (mm)	Working Load Limit (t)*	Weight Each (kg)
5	H	665444	HW261-B	Bronze Bushed	10	.54	.91
5	H	665462	HW262-B	Bronze Bushed	10	.82	1.81

* Ultimate Load is 3 times the Working Load Limit.



HW-262B

Western Blocks for Manila Rope



SEE APPLICATION AND WARNING INFORMATION

Para Español: www.thecrosbygroup.com

On Pages 332-339

Manila Rope Snatch Blocks



**T-390
PAINTED**



**T-390
GALVANIZED**



**T-385
PAINTED**



**T-385
GALVANIZED**

Steel Shell & Wood Shell

- New style blocks feature higher working load limits.
- Painted or Galvanized steel with replaceable wood bumpers.
- Laser cut side plate opens for insertion of wire rope.
- Incorporates exclusive bolt retaining sprint to assure no lost bolts, plus utilizes secondary retaining pin.
- Bronze bushed sheaves with larger bearing diameter for extended block life.
- Utilizes Crosby "N" style hooks with integrated latch.
- Lubricated center pin.
- 10" and 12" sizes utilize steel sheaves.

Block Size (in.)	Fitting	Wood Shell		Steel Shell	
		385-B* Stock No. S.C.	385-B* Stock No. Galv.	390-B* Stock No. S.C.	390-B* Stock No. Galv.
6	T	702000	702108	702216	702324
8	T	702009	702117	702225	702333
10	T	702018	702126	702234	702342
12	T	702027	702135	702243	702351
6	J	702036	702144	702252	702360
8	J	702045	702153	702261	702369
10	J	702054	702162	702270	702378
12	J	702063	702171	702279	702387
6	G	702072	702180	702288	702396
8	G	702081	702189	702297	702405
10	G	702090	702198	702306	702414
12	G	702099	702207	702315	702423

* Bearing Code: B-Self Lubricating Bronze Bushed, C-Common Iron, R-Roller Bearing

Block Size (in.)	Sheave Size (mm)			Manila Rope Size (mm)	Drop Side	
	Outside Diam.	Rim Thickness	Bearing Diameter		Working Load Limit (t)*	Weight Each (kg.)
6	76.2	22.4	19.1	19-22	2.0	3.18
8	102	35.1	25.4	25-28	4.0	5.90
10	152	41.1	38.1	32	8.0	11.3
12	203	41.1	38.1	38	8.0	15.4

* Ultimate Load is 4 times the Working Load Limit.

Western Blocks for Manila Rope

SEE APPLICATION AND WARNING INFORMATION
 Para Español: www.thecrosbygroup.com On Pages 332-339



T-350-C

Gin Blocks for Manila Rope

- For light hoisting by Roofers and Contractors.
- Furnished with drop forged swivel latch hooks.

Block Size (in.)	Fitting	Gin Block Stock No.			Sheave Size (mm)			Manila Rope Size (mm)	Working Load Limit (t)*	Weight Each (kg)
		T-350-B	T-350-R	T-350-C	Outside Diam.	Rim Thickness	Bearing Diam.			
8	T	710403	710207	710001	203	31.8	19.1	22	.45	4.10
10	T	710421	710225	710029	254	31.8	22.4	26	.45	5.45
12	T	710449	710243	710047	305	35.1	22.4	26	.45	7.25

* Ultimate Load is 3 times the Working Load Limit.

Bearing Code: B-Self Lubricating Bronze Bushed, R-Roller Bearing, C-Common Iron



**HS-130-B
SINGLE**

Painter's Supply Blocks for Manila Rope

- Furnished in Bronze Bushed.
- For 3/4" (19mm) Manila Rope.
- Steel Parts are Galvanized.
- Furnished with Loose Side Hooks with Latch or Shackle.

Block Size (in.)	Fitting	Single Sheave Blocks	Double Sheave Blocks	
		HS-130 B* Stock No.	HS-135 B* Stock No.	P-135 B* Stock No.
6	HS	601236	631034	-
6	HS	-	-	8004829

* Bearing Code: B-Self Lubricating Bronze Bushed

Block Size (in.)	Sheave Size (mm)			Manila Rope Size (mm)	Resultant Working Load Limit (t)*		Weight Each (kg)	
	Outside Diam.	Rim Thickness	Center Pin Dia.		130 Single	135 Double	130 Single	135 Double
6	89.0	25.4	19.1	19	.82	1.13	2.27	4.54

* Ultimate Load is 4 times the Resultant Working Load Limit.

Western Regular Wire Rope Blocks



SEE APPLICATION AND WARNING INFORMATION

Para Español: www.thecrosbygroup.com

On Pages 332-339

Diamond & Oval Pattern Regular Wire Rope Blocks



T-641-B

- Laser cut painted side plates (can be furnished galvanized upon request).
- Grade 5 bolts secured with lock washers and staked nuts.
- All sizes feature bronze bushed steel sheaves with larger bearing diameter for extended block life.
- New style hanger for fitting attachment
- Available with hanger only (no fitting).
- For reeving information, see page 336.

Block Size (in.)	Fitting	Diamond Pattern with Bronze Bushed Steel Sheaves		Oval Pattern with Bronze Bushed Steel Sheaves	
		641-B Single	642-B Double	661-B Single	662-B Double
4	T	-	782193	791183	791593
6	T	781611	782219	-	791619
8	T	781639	782237	791236	791637
10	T	781657	782255	791254	791655
4	S	-	786199	-	-
6	S	785902	786206	795900	796204
8	S	785920	786224	-	-
10	S	785948	786242	795946	796240
6	J	782102	782503	791502	791904
8	J	782120	782521	791520	791922
10	J	782148	782549	791548	791940
6	E	782004	782406	791307	791708
8	E	782022	782424	791325	791726
10	E	782040	782442	791343	791744



S-642-B

Block Size (in.)	Sheave Size (mm)		Wire Rope Size (mm)	Working Load Limit (t)*		Weight Each (kg)	
	Outside Diam.	Rim Thickness		641 661 Single	642 662 Double	641 661 Single	642 662 Double
4	102	19.1	10	.91	1.82	3.6	5.0
6	152	25.4	13	2.72	3.60	6.8	9.5
8	203	31.8	16	3.60	5.44	12.7	18.6
10	254	31.8	16	3.63	6.35	17.2	27.2

* Ultimate Load is 4 times the Working Load Limit.

Western Block Fittings

FOR MANILA OR WIRE ROPE BLOCKS

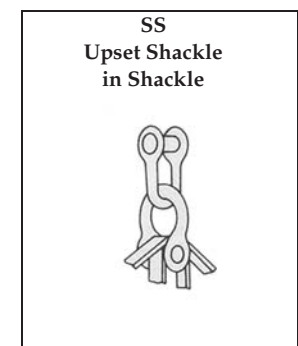
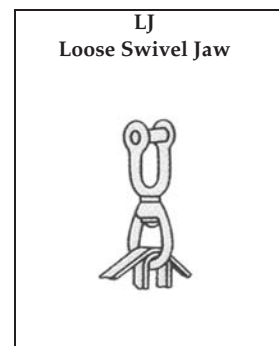
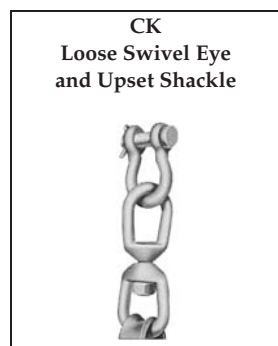
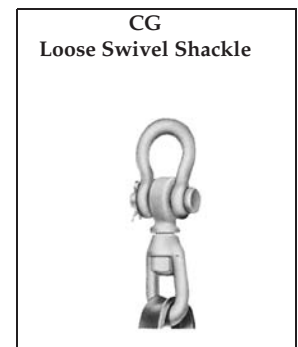
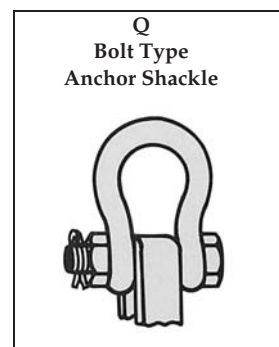
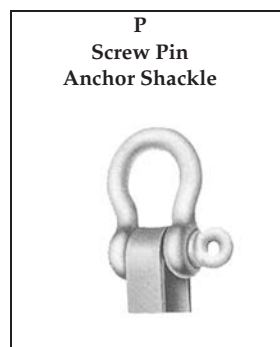
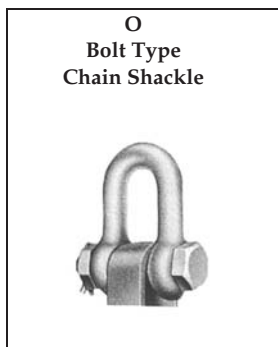
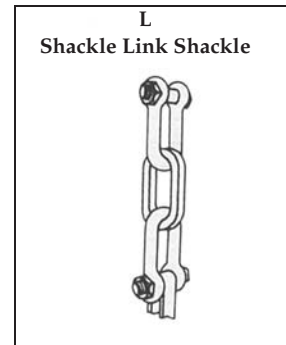
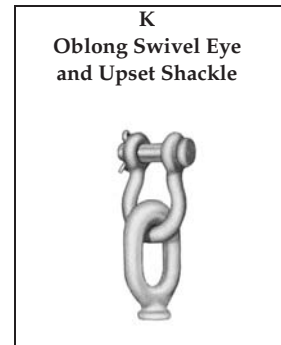
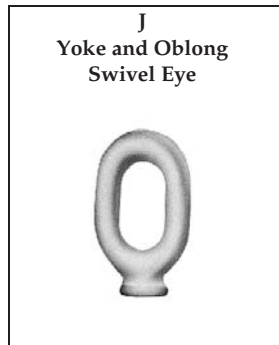
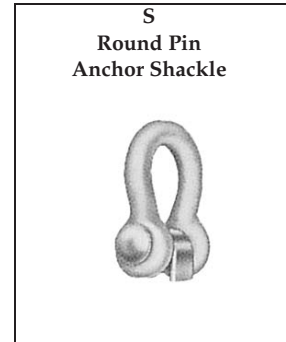
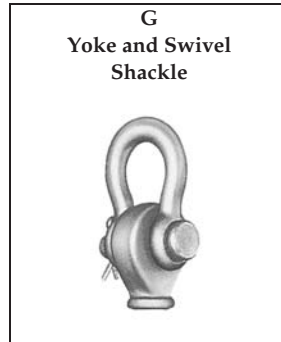
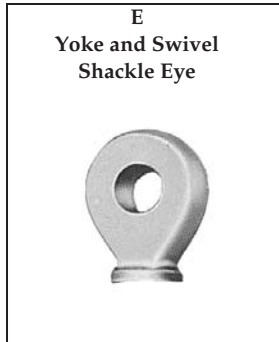

Fittings for Western Cargo Blocks

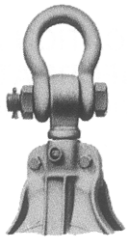

QC
Swivel Bolt Type
Shackle



J
Oblong Swivel
Eye



QK
Upset Swivel
Bolt Type



U
Goose Neck
Swivel Eye



Z
Non-toppling
Guard

Note: When ordering blocks with special fittings, specify figure number of block and letter of fitting.

HEEL AND LEAD BLOCK ADJUSTER FITTINGS (For use with E-566 Cargo Blocks)

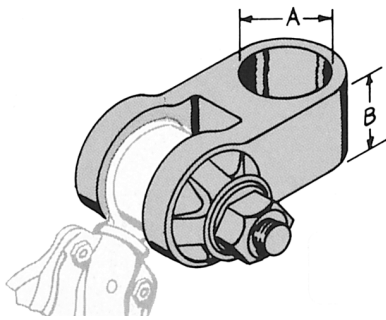

No. 572

Self-adjuster Fitting with Tension Pin, Cup Spring and Washers.

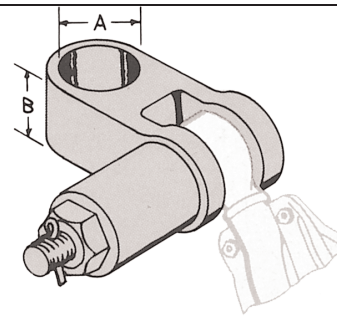

No. 573

Self-adjuster Fitting with Tension Pin, Coil Spring, Cup and Washers.

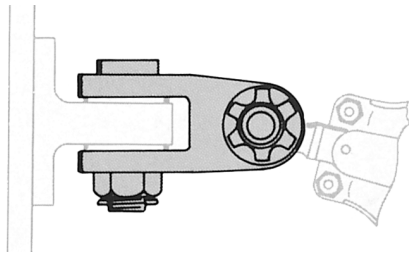

No. 574

Self-adjuster Fitting with Tension Pin, Cup Spring and Washers, and King Pin to fit Pad Eye (can also be furnished with 2 Tension Pins).

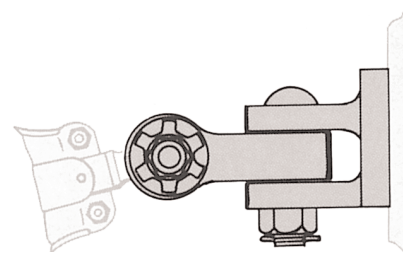

No. 576

Self-adjuster Fitting with Pad Jaw, King Pin, Tension Pin, Cup Spring and Washers.

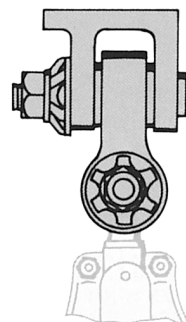

No. 575

Self-adjuster Fitting with Tension Pin, Cup Spring, and Washer.

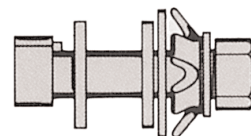

No. 571

Tension Pin with Cup Spring, Nut and Washers.

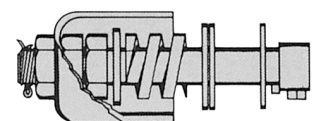

No. 570

Tension Pin with Coil Spring, Nut and Washers, Cotter and Cup.

When ordering Specify: "A" - Pin Diameter, "B" - Height of Fitting, and Tension Pin Diameter.

Western Lead Blocks



SEE APPLICATION AND WARNING INFORMATION

Para Español: www.thecrosbygroup.com

On Pages 332-339

600-S

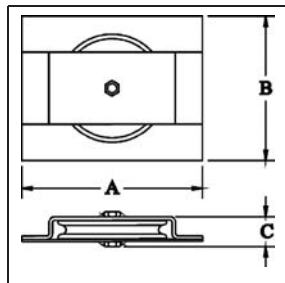

Horizontal Lead Blocks

- Available painted or galvanized.
- Fitted with steel sheaves.
- Self Lubricated Bronze Bushed.

Sheave Diameter (mm)	600 Series Stock No.		Resultant Working Load Limit (t)*	Wire Rope Size (mm)	Weight Each (kg)	Dimensions (mm)		
	600-S Painted	600-S Galv.				A	B	C
152	771999	772006	1.81	10	5.6	279	162	63.5
203	772015	772024	2.27	13	9.5	330	216	76.0
254	772033	772042	2.72	16	16.3	381	267	82.5
305	772051	772060	3.63	19	27.7	432	318	102
356	772079	772088	4.54	22	43.0	483	368	102

* Ultimate Load is 4 times the Resultant Working Load Limit.

601-S

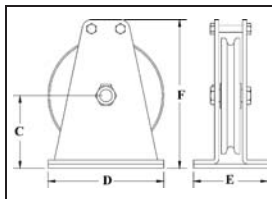

Vertical Lead Blocks

- Available painted or galvanized.
- Fitted with steel sheaves.
- Self Lubricated Bronze Bushed.

Sheave Diameter (mm)	601 Series Stock No.		Resultant Working Load Limit (t)*	Wire Rope Size (mm)	Weight Each (kg)	Dimensions (mm)			
	601-S Painted	601-S Galv.				C	D	E	F
152	772195	772202	1.81	10	4.54	89.0	152	140	178
203	772211	772220	2.27	13	11.1	124	203	171	248
254	772239	772248	2.72	16	14.3	162	254	197	298
305	772257	772266	3.63	19	28.6	184	305	203	387
356	2003424	2003425	4.54	22	44.5	222	356	229	457

* Ultimate Load is 4 times the Resultant Working Load Limit.

Western Lead Blocks

SEE APPLICATION AND WARNING INFORMATION
 Para Español: www.thecrosbygroup.com On Pages 332-339

602-S

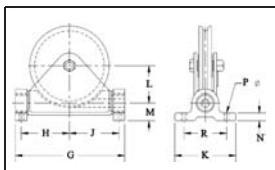

Flag Blocks

- Base plates are drilled.
- Available painted or galvanized.
- Fitted with steel sheaves.
- Self-lubricated Bronze Bushed.

Sheave Diameter (mm)	602 Series Stock No.		Resultant Working Load Limit (t)*	Wire Rope Size (mm)	Weight Each (kg)	Dimensions (mm)								
	602-S Painted	602-S Galv.				G	H	J	K	L	M	N	P	R
152	772391	772408	1.81	10	7.71	229	95.5	98.5	159	73.0	41.1	19.1	14.2	121
203	1420885	772426	2.27	13	14.3	289	121	130	178	92.0	51.0	25.4	17.5	140
254	772435	772444	2.72	16	19.1	340	145	154	178	117	51.0	25.4	17.5	140
305	772453	772462	3.63	19	52	438	184	197	273	137	79.0	35.1	20.6	191
356	772471	-	4.54	22	62	489	216	222	273	165	79.0	35.1	20.6	191

* Ultimate Load is 4 times the Resultant Working Load Limit.

603-S

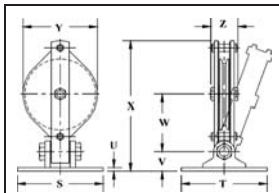

Hinged Lead Blocks

- Base plates are not drilled.
- Available painted or galvanized.
- Self-lubricated Bronze Bearings.

Sheave Diameter (mm)	603 Series Stock No.		Resultant Working Load Limit (t)*	Wire Rope Size (mm)	Weight Each (kg)	Dimensions (mm)							
	603-S Painted	603-S Galv.				S	T	U	V	W	X	Y	Z
152	772596	772603	1.81	10	13.6	152	114	12.7	51.0	148	325	171	82.5
203	772612	772621	2.27	13	15.4	203	171	9.65	66.5	167	393	229	95.5
254	772630	772649	2.72	16	20.4	305	305	12.7	70.0	203	464	273	111
305	772658	772667	3.63	19	34.0	305	305	12.7	70.0	241	473	330	116
356	772676	772685	4.54	22	45.4	305	305	12.7	70.0	273	524	381	122

* Ultimate Load is 4 times the Resultant Working Load Limit.

Copyright © 2006 The Crosby Group, Inc.

All Rights Reserved

McKissick® Horizontal & Vertical Sheaves



SEE APPLICATION AND WARNING INFORMATION

Para Español: www.thecrosbygroup.com

On Pages 332-339

461 VERTICAL LEAD SHEAVES

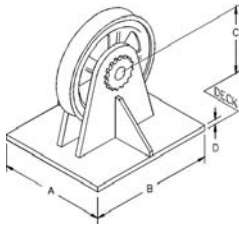

Furnish the following important information when ordering:

- A, B, and C dimensions.
- Line pull in pounds and degree of wrap.
- Line speed.
- Diameter of wire rope.
- Roller bearings, bronze bushings, or sealed double row tapered bearings.

463 HORIZONTAL LEAD SHEAVES

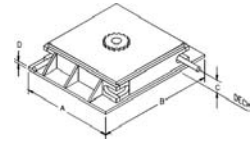

Guide and control your deck lines with McKissick's deck-mounted wire rope sheaves.

Built to your specific requirements.

- Extra heavy construction, built to withstand breaking strength of indicated rope (XIP, IWRC).
- Flame-hardened sheaves, machined grooves for proper rope size.
- For special requirements, contact Crosby.

Figure No.	Lead Sheave Stock No.	Sheave Diameter (mm)	Standard Wire Rope Size (mm)	Weight Each (kg)	Dimensions (mm)			
					A	B	C	D
461-18	239753	457	22	227	305	508	279	38.1
461-24	131574	610	32	227	381	660	356	38.1
461-26	238120	660	38	299	406	711	381	38.1
461-36	148389	914	42	386	508	914	495	50.8
461-40	136285	1016	50	910	584	1067	572	50.8
461-42	130753	1067	64	1814	711	1321	648	63.5
463-26	4440359	660	26	448	838	838	95.5	38.1
463-30	1404377	762	32	556	940	940	89.0	38.1
463-36	146522	914	38	862	1092	1092	89.0	38.1
463-42	1406525	1067	44	1350	1270	1270	111	51.0
463-48	131583	1219	50	1630	1397	1397	118	51.0
463-60	123164	1524	64	2900	1727	1727	146	51.0

457



Deck Mounted Anchor Fairleader

- Barrel and sheaves equipped with sealed double row tapered bearings.
- Extra heavy construction, built to withstand breaking strength of indicated rope at 90 degree sheave wrap and 45 degree head swing.
- All bearings Alemite-lubricated.
- Custom Anchor Fairleader sets available.

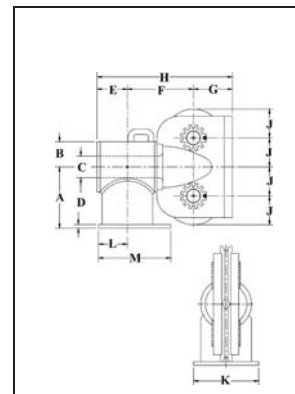

Figure No.	457 Stock No.	Sheave Diameter (mm)	Wire Rope Size (mm)	Weight Each (kg)	Dimensions (mm)											
					A	B	C	D	E	F	G	H	J	K	L	M
B-10-D	8073880	254	26	136	273	114	89.0	19.1	127	257	171	556	129	241	114	279
B-12-D	8073924	305	32	272	324	127	127	19.1	162	314	203	679	154	279	133	330
B-16-D	8073979	406	38	590	432	178	152	25.4	214	451	273	938	205	457	203	508
B-20-D	8074022	508	44	1134	533	229	216	25.4	286	557	324	1167	256	533	254	622
B24-D	8074111	610	52	1633	641	279	254	31.8	324	673	375	1372	306	584	279	686

McKissick® Trawl & Try Net Blocks

SEE APPLICATION AND WARNING INFORMATION
 Para Español: www.thecrosbygroup.com On Pages 332-339

J-452
Oblong Swivel Eye



Double Rig Trawl Blocks

- Steel sheave with flame hardened groove, for maximum wear under abrasive conditions.
- Double row, permanently sealed tapered roller bearings.
- Pressure lubrication throughout.
- All steel construction.
- Hot Dip galvanized.

Sheave Dia. and Block No.	452 Stock No.	Working Load Limit (t)*	Weight Each (kg)	Sheave Dimensions (mm)	
				Outside Diameter	Rim Thickness
8" J-452	130655	9.07	21.8	203	95.5
12" J-452	130673	9.07	38.6	305	95.5
16" F-452	130682	18.14	53.0	406	95.5
18" J-452	2015467	22.50	136	457	138
22" F-452	130708	27.22	109	559	95.5

* Ultimate Load is 4 times the Working Load Limit.

NOTE: 18" J-452 utilizes a Manganese Steel Sheave that is not flame hardened.



F-453 6"

Try Net Blocks

- Forged steel swivel eyes.
- Hot Dip galvanized.
- 6" 453 - Pressed steel side plates with flared edges. Figure 8 grooved, self-lubricating bronze bushed sheaves, with pressure lube fittings. 453 has an extra wide throat opening to allow fittings to pass through.
- 6" 454 - Forged side plates designed to eliminate rope jamming. Wide throat opening and pressure lube fitting on sheave and eye fitting.
- 8" 454 - Forged steel side plates designed to eliminate possibility of rope jamming. Furnished with sealed tapered bearings. Flame hardened forged steel sheaves for wear resistance.

Sheave Dia. and Block No.	Bearing Type	Try Net Block Stock No.	Working Load Limit (t)*	Weight Each (kg)	Sheave Dimensions (mm)	
					Outside Diameter	Rim Thickness
6" F-453	Bronze Bushed	769886	4.54	15.9	152	70.0
6" F-454	Needle Bearing	2001763	4.54	10.4	152	70.0
8" J-454	Tapered Bearing	130726	9.07	16.3	203	73.0

* Ultimate Load is 4 times the Working Load Limit.



F-454 6"



J-454 8"

Western Wire Rope Blocks



SEE APPLICATION AND WARNING INFORMATION

Para Español: www.thecrosbygroup.com

On Pages 332-339

New Style Oval Pattern Construction Blocks

- All blocks are galvanized.
- Sheave lubricated through pressure lube fitting in center pin.
- Assembled with self lubricated bronze bushing.
- Combines weight of regular oval blocks with strength of extra heavy oval blocks.
- Assembled with bolt type anchor shackle.
- Side plates are rounded to provide additional stiffness and reduce wear and chaffing of the rope.



Q-681-Z



Q-682-Z



Q-683-Z

Block Size (in.)	Fitting	Stock No. Bronze Bushed Steel Sheaves		
		Q-681-Z	Q-682-Z	Q-683-Z
6	Q	760441	760665	-
6	Q	760452	760676	760812
8	Q	760463	760687	-
10	Q	760474	760698	760834

Block Size (in.)	Sheave Dimensions (mm)			Wire Rope Size (mm)	Working Load Limit (t)*			Weight Each (kg)		
	Outside Diameter	Rim Thickness	Center Pin Diameter		Single	Double	Triple	Single	Double	Triple
6	152	25.4	19.1	10	2.70	3.63	-	6.8	12.7	-
6	152	25.4	19.1	13	2.70	3.63	4.50	7.3	12.7	14.5
8	203	31.8	25.4	16	3.63	5.44	-	13.2	20.4	-
10	254	31.8	25.4	16	3.63	6.35	7.25	17.2	27.7	36.3

* Ultimate Load is 4 times the Working Load Limit.

Bearing Code: Z - Self Lubricating Bronze Bushed with pressure lube fitting.

S-2131



S-2131 Trawling Shackles

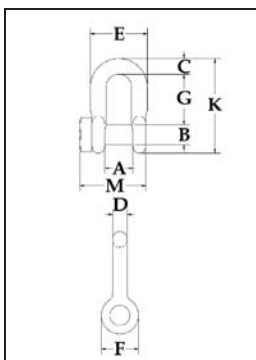

Nominal Shackle Size D (in.)	Working Load Limit (t)*	S-2131 Stock No.	Weight Each (kg)	Dimensions (mm)										Tolerance +/-	
				A	B	C	D	E	F	G	K	M	G	A	
1/2	2	1018703	.34	20.6	16.0	12.7	12.7	46.0	30.2	41.4	78.5	56.5	3.30	1.50	
5/8	3-1/4	1018721	.56	27.0	19.1	16.0	16.0	58.5	39.6	51.0	96.0	70.0	3.30	1.50	
3/4	4-3/4	1018749	.99	31.8	22.4	20.6	19.1	70.0	47.8	60.5	114	82.5	6.35	1.50	
7/8	6-1/2	1018767	1.49	36.6	25.4	24.6	22.4	81.0	54.0	71.5	133	93.5	6.35	1.50	
1	8-1/2	1018785	2.27	42.9	28.7	25.4	26	93.5	60.5	81.0	151	108	6.35	1.50	
1-1/8	9-1/2	1018803	3.16	46.0	31.8	31.8	28	103	68.5	91.0	172	117	6.35	1.50	

* Ultimate Load is 4 times the Working Load Limit. Also available in Anchor Type S-2091.

Western Cargo Hoisting Blocks

SEE APPLICATION AND WARNING INFORMATION
 Para Español: www.thecrosbygroup.com On Pages 332-339



**E-566
W/DRILLED
SWIVEL EYE**



**J-566
W/OBLONG
SWIVEL EYE**

566 Cargo Hoisting Blocks

- Block is galvanized.
- Blocks 356mm and larger have flame-hardened Roll Forged™ sheaves that assure greater wire life.
- Roll Forged™ sheave is fitted closely into mortise of shell so wire cannot jam between sheave and shell.
- Available for 19mm or 25mm wire.
- Block is fitted with tapered roller bearings which take both load and side thrusts and hold sheave central so it cannot chafe or wear on the sides.
- Tapered Roller bearing with neoprene seals and stainless steel center pin, provide long life and trouble-free service.
- Stainless steel center pin has recessed nuts with lock washers.
- Swivel fitting has permanently sealed thrust bearing.
- Pressure lubrication fittings are standard on both center pin and swivel.
- Individually Proof Tested at 4 times Working Load or 2 times Resultant Load.
- A.B.S. recognized load test certificates are furnished.
- The Working Load for Cargo hoisting blocks is the line pull.

Sheave Size (mm)	Block No.	566 Stock No.	Working Load Limit (t)*	Wire Rope Size (mm)	Weight Each (kg)
305	E-566	775003	4.54	19	43.1
305	J-566	775209	4.54	19	43.1
305	G-566	775405	4.54	19	43.1
305	K-566	775600	4.54	19	43.1
305	QG-566	775806	4.54	19	43.1
305	QK-566	776002	4.54	19	43.1
356	E-566	775058	9.07	19	45.4
356	J-566	775254	9.07	19	45.4
356	QG-566	775450	9.07	19	45.4
356	QK-566	775655	9.07	19	45.4
356	PG-566	775851	9.07	19	45.4
356	PK-566	776057	9.07	19	45.4
356	E-566	775067	9.07	25	45.4
356	J-566	775263	9.07	25	45.4
356	QG-566	775469	9.07	25	45.4
356	QK-566	775664	9.07	25	45.4
356	PG-566	775860	9.07	25	45.4
356	PK-566	776066	9.07	25	45.4
406	E-566	776609	9.07	19	59
406	J-566	776672	9.07	19	59
406	QG-566	776681	9.07	19	59
406	QK-566	776690	9.07	19	59
406	PG-566	776707	9.07	19	59
406	PK-566	776716	9.07	19	59
406	E-566	752956	9.07	25	59
406	J-566	752965	9.07	25	59
406	QG-566	752974	9.07	25	59
406	QK-566	752983	9.07	25	59
406	PG-566	752992	9.07	25	59
406	PK-566	753009	9.07	25	59

* Working Load equals maximum single line pull. Resultant Load equals 2 times single line pull. Ultimate Load equals 5 times the Resultant Load.